

Venting Components – DuraTech

DuraTech

DuraTech is a double-wall, all-fuel chimney system for use w/ wood stoves, fireplaces, furnaces, boilers, ranges, water heaters, or other appliances fueled by wood, oil, coal, or gas, and zero-cleared fireplaces that are factory built.

Available in 5" – 8" diameter

Installation Key

1	DVL or DuraBlack	11	Tee w/ Tee Cap
2	Ceiling Support Box	12	Tee Support
3	Wall Thimble	13	Chase Top Flashing
4	Chimney Pipe	14	Base Tee/Double Tee
5	Attic Insulation Shield	15	Anchor Plate or Anchor Plate w/ Damper
6	Flashing	16	Roof Support
7	Storm Collar	17	Finishing Collar
8	Chimney Cap	18	DVL Adapter, DuraBlack Slip Connector, or Snap-Lock Adapter
9	Elbow	19	DLV Adapter
10	Elbow Strap		

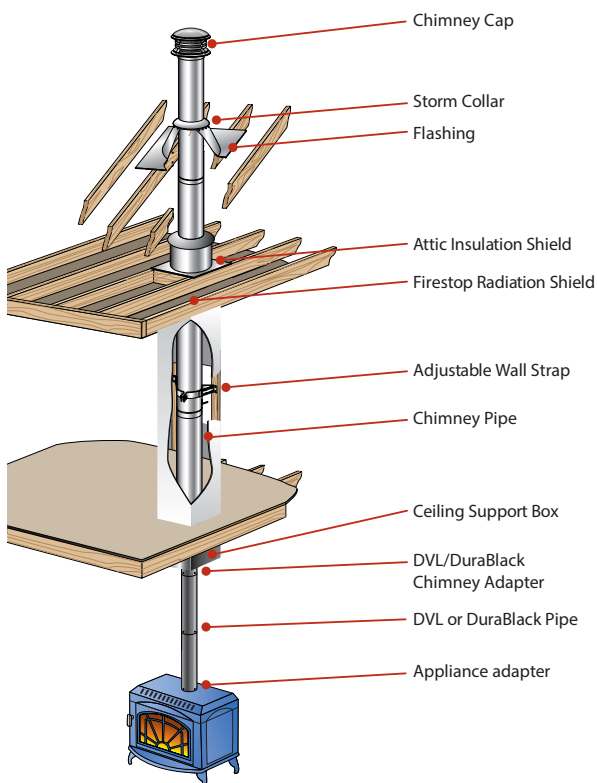
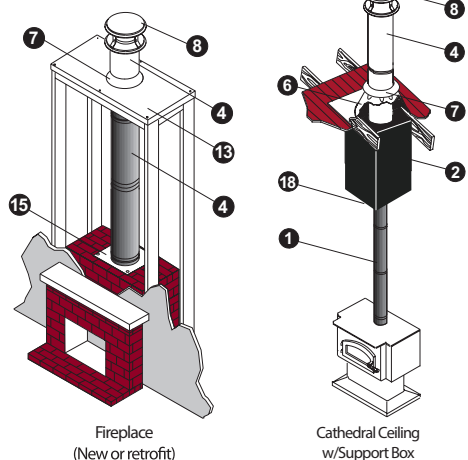
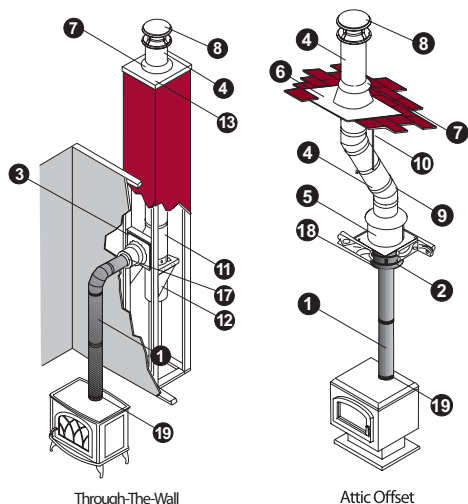
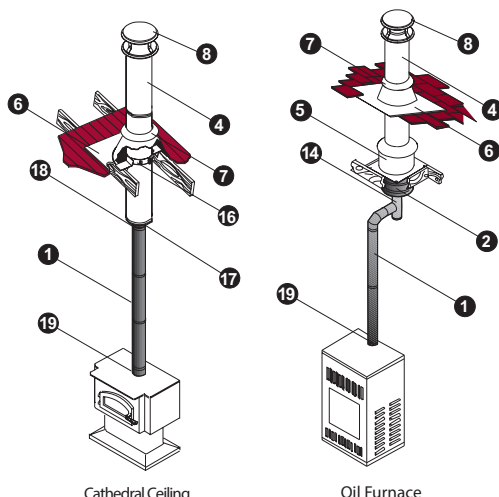

SOME BRANDS ARE ONLY AVAILABLE IN SELECTED AREAS, SEE MAP ON PAGE 4 OR CONTACT YOUR REGIONAL SALES MANAGER FOR MORE INFO.

Pricing, model numbers and availability are subject to change without notice. Call for most current information.

Chimney Pipe

A	6"	List Price	7"	List Price	8"	List Price
B	8"		9"		10"	
LENGTH						
6" GA	6DT-06	\$104.71	7DT-06 ❖	\$203.76	8DT-06 ❖	\$120.33
6" SS	6DT-06SS	\$135.97	7DT-06SS ❖	\$291.10	8DT-06SS ❖	\$220.41
9" GA	6DT-09	\$129.74	7DT-09 ❖	\$279.90	8DT-09 ❖	\$151.59
12" GA	6DT-12	\$153.19	7DT-12 ❖	\$178.17	8DT-12	\$182.87
12" SS	6DT-12SS	\$154.74	7DT-12SS ❖	\$226.65	8DT-12SS	\$276.65
18" GA	6DT-18	\$193.81	7DT-18 ❖	\$307.89	8DT-18 ❖	\$229.75
18" SS	6DT-18SS	\$211.03	7DT-18SS ❖	\$256.35	8DT-18SS ❖	\$301.65
24" GA	6DT-24	\$245.44	7DT-24CF ❖	\$304.41	8DT-24	\$296.97
24" SS	6DT-24SS	\$281.36	7DT-24SSCF ❖	\$331.16	8DT-24SS	\$357.94
36" GA	6DT-36	\$322.00	7DT-36CF ❖	\$426.52	8DT-36	\$426.74
36" SS	6DT-36SS	\$375.13	7DT-36SSCF ❖	\$516.85	8DT-36SS	\$565.86
48" GA	6DT-48CF	\$426.52	7DT-48CF ❖	\$490.09	8DT-48CF	\$525.17
48" SS	6DT-48SSCF	\$516.85	7DT-48SSCF ❖	\$587.07	8DT-48SSCF	\$689.10
60" GA	6DT-60CF	\$499.31	7DT-60CF ❖	\$520.74	8DT-60CF ❖	\$557.88
60" SS	6DT-60SSCF	\$613.46	7DT-60SSCF ❖	\$647.57	8DT-60SSCF	\$721.10

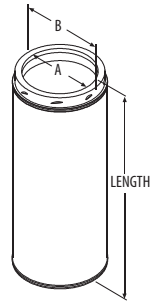

NOTE: PART NUMBERS ENDING IN CF HAVE ADDITIONAL PROTECTIVE CARTON FILLER FOR SHIPPING.

Venting Components – DuraTech

Adjustable Pipe

Use to add length to DuraTech Chimney. Adjusts from 14"-21".

SIZE	6"	List Price	8"	List Price
A	14"-21"		14"-21"	
STOCK #	6DT-21TASS	\$464.77	8DT-21TASS ❖	\$522.87

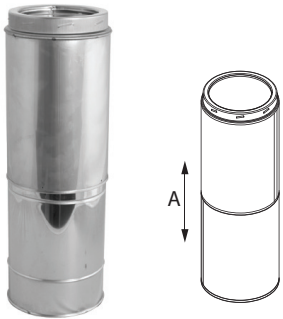

Elbow Kit

30°	6"	List Price	7"	List Price	8"	List Price
GA STOCK #	6DT-E30K	\$719.20	7DT-E30K ❖	\$811.06	8DT-E30K	\$869.32
SS STOCK #	6DT-E30KSS	\$989.65	7DT-E30KSS ❖	\$1,111.78	8DT-E30KSS ❖	\$1,192.87

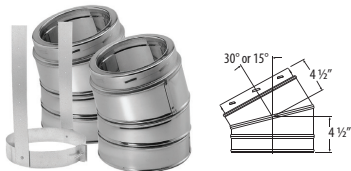

Adjustable Elbow Strap

Use to prevent excessive weight on the elbows by supporting the weight of the chimney. Required to be installed between two elbows in offset application.

SIZE	6"	List Price
A	8", 10"	
STOCK #	6DT-AES*	\$90.83

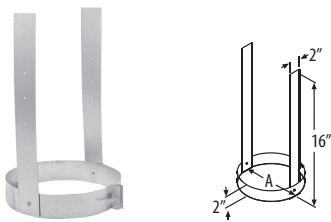

Square Ceiling Support Box

Supports chimney pipe and provides a positive connection between support box and chimney.

SIZE	6"	7"	8"	CEILING PITCH		
				DURABLACK	DVL	USE
A	6 1/4"	7 1/4"	8 1/4"	0/12 – 4/12	0/12 – 6/12	11" Support Box
B	9"	11"	11"	5/12 – 9/12	7/12 – 13/12	24" Support Box
C	12"	13"	14 1/4"	10/12 – 14/12	14/12 – 20/12	36" Support Box

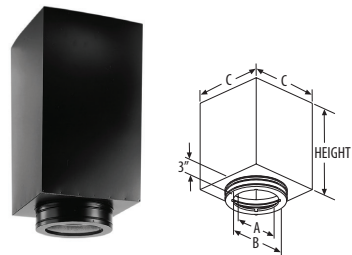

HEIGHT	6"	List Price	7"	List Price	8"	List Price
11"	6DT-CS11	\$311.06	7DT-CS11 ❖	\$465.77	8DT-CS11 ❖	\$340.75
24"	6DT-CS24	\$345.50	7DT-CS24 ❖	\$523.99	8DT-CS24	\$379.84
36"	6DT-CS36	\$381.41	7DT-CS36 ❖	\$697.96	8DT-CS36 ❖	\$422.06

SOME BRANDS ARE ONLY AVAILABLE IN SELECTED AREAS, SEE MAP ON PAGE 4 OR CONTACT YOUR REGIONAL SALES MANAGER FOR MORE INFO.

Pricing, model numbers and availability are subject to change without notice. Call for most current information.

Reduced Clearance Square Ceiling Support Box

Supports chimney pipe and provides a positive connection between support box and chimney with a built-in twist-lock.

SIZE	6"	List Price
A	6 1/4"	
B	9"	
C	10"	
HEIGHT		
24"	6DT-CS24R	\$325.15

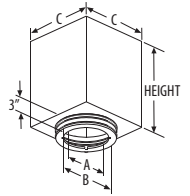

Round Ceiling Support Box

SIZE	6"	List Price	7"	List Price	8"	List Price
A	6 1/4"		7 1/4"		8 1/4"	
B	9"		11"		11"	
C	12"		13"		14"	
STOCK #	6DT-RCS	\$163.02	7DT-RCS ❖	\$465.77	8DT-RCS ❖	\$261.99

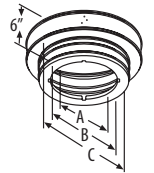

Trim Collar for Round Support Box

Conceals the gap between the round support box and the ceiling cutout.

SQUARE TRIM COLLAR				
SIZE	5"- 6"	List Price	7"- 8"	List Price
A	9 1/8"		11 1/8"	
B	14"		16"	
STOCK #	5DT-TC	\$93.75	7DT-TC ❖	\$95.35

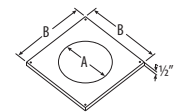
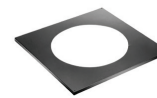

ROUND TRIM COLLAR				
SIZE	5"- 6"	List Price	7"- 8"	List Price
A	9 1/8"		11 1/8"	
B	17 1/2"		21"	
STOCK #	5DT-TCR	\$98.43	7DT-TCR ❖	\$101.56

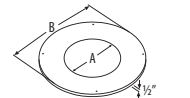
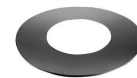

Flat Ceiling Support Box

SIZE	6"	List Price	7"	List Price	8"	List Price
A	6 1/4"		7 1/4"		8 1/4"	
B	9"		11"		11"	
C	12"		13"		14 1/4"	
STOCK #	6DT-FCS	\$211.03	7DT-FCS ❖	\$407.93	8DT-FCS ❖	\$218.81

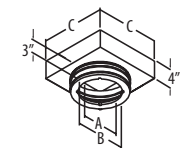

SOME BRANDS ARE ONLY AVAILABLE IN SELECTED AREAS, SEE MAP ON PAGE 4 OR CONTACT YOUR REGIONAL SALES MANAGER FOR MORE INFO.

Pricing, model numbers and availability are subject to change without notice. Call for most current information.

❖ - Non Stock Special Order - NO RETURNS or CANCELLATIONS

RMI Ph: 800-628-5044

raymurray.com

Venting Components – DuraTech

Adjustable Roof Support

Designed to support the DuraTech chimney and allows the chimney to pass through the roof and extend down from the ceiling.

SIZE	5" & 7"	List Price	6" & 8"	List Price
A	7", 9"		8", 10"	
STOCK #	5DT-ARS	\$151.38	6DT-ARS	\$151.37

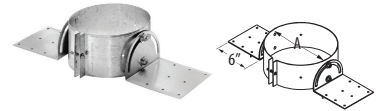

Wall Thimble

Adjusts from a minimum of 5 1/2" to a maximum of 9 1/2" wall thickness, and fits between standard wall studs.

SIZE	6"		7"		8"	
A	8 1/8"		9 1/8"		10 1/8"	
B	14"		16"		16"	
C	11 7/8"		12 7/8"		13 7/8"	
D	14"		15"		16"	
STOCK #	6DT-WT	\$157.85	7DT-WT ❖	\$320.21	8DT-WT	\$201.59
SSTRIM	6"	List Price	7"	List Price	8"	List Price
STOCK #	6DT-WTSS	\$91.69	--		8DT-WTSS ❖	\$99.33

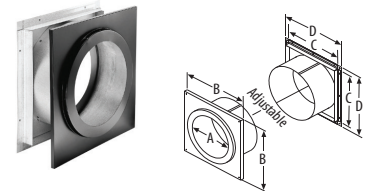

Finishing Collar w/ Adapter

New integrated collar w/ Adapter, fits into the female end of the chimney pipe to provide a decorative black finish.

SIZE	6"	List Price	8"	List Price
STOCK #	6DT-FC	\$95.72	8DT-FC	\$110.74



Trim Collar for Roof Support

SIZE	6"	List Price	8"	List Price
STOCK #	6DT-RSTC3	\$123.43	8DT-RSTC3 ❖	\$126.59
STOCK #	6DT-RSTC6 ❖	\$123.43	8DT-RSTC6 ❖	\$126.59
STOCK #	6DT-RSTC9 ❖	\$123.43	8DT-RSTC9 ❖	\$126.59

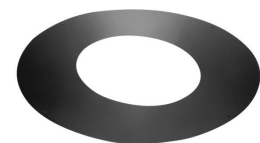

SOME BRANDS ARE ONLY AVAILABLE IN SELECTED AREAS, SEE MAP ON PAGE 4 OR CONTACT YOUR REGIONAL SALES MANAGER FOR MORE INFO.

Pricing, model numbers and availability are subject to change without notice. Call for most current information.

Venting Components – DuraTech

Tee w/ Cap

Use for through-the-wall installations. Includes removable tee cap for easy chimney cleaning or inspection.

SIZE	6"	List Price	7"	List Price	8"	List Price
SS STOCK #	6DT-STSS	\$529.93	7DT-STSS ❖	\$695.61	8DT-STSS ❖	\$786.29



Adjustable Tee Support Bracket

Use as a wall support for chimney system.

SIZE	6"	List Price	7"	List Price	8"	List Price
A	8"		9"		10"	
B	10"		12"		12"	
C	11"		13"		13"	
D	11 3/4"		13 3/4"		13 3/4"	
GA STOCK #	6DT-TSB	\$200.07	7DT-TSB ❖	\$250.12	8DT-TSB ❖	\$290.74
SS STOCK #	6DT-TSBSS	\$486.15	7DT-TSBSS ❖	\$519.06	8DT-TSBSS ❖	\$572.12

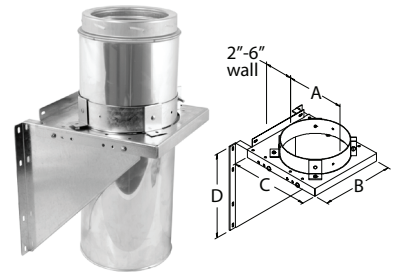

Wall Strap

Use in interior or exterior installations to add lateral support to the chimney.

SIZE	6"	List Price	8"	List Price
A	8"		10"	
B	11 3/4"		14"	
GA STOCK #	6DT-WS	\$82.84	8DT-WS	\$107.82
SS STOCK #	6DT-WSSS	\$145.36	8DT-WSSS	\$154.74

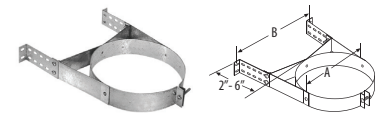

Anchor Plate

Use to attach DuraTech chimney to an appliance or masonry fireplace.

SIZE	6"	List Price	7"	List Price	8"	List Price
A	6"		7"		8"	
B	8"		9"		10"	
C	10"		11"		12"	
STOCK #	6DT-AP	\$128.16	7DT-AP ❖	\$160.98	8DT-AP	\$179.75

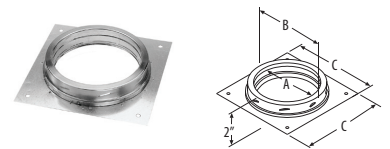

Venting Components – DuraTech

Firestop Radiation Shield

Use in ceiling/floor penetrations when a ceiling support is not used.

SIZE	6"	List Price	7"	List Price	8"	List Price
A	8 1/8"		9 1/8"		10 1/8"	
B	11 7/8"		12 7/8"		13 7/8"	
C	14"		15"		16"	
STOCK #	6DT-FRS	\$123.43	7DT-FRS ❖	\$192.13	8DT-FRS	\$154.74

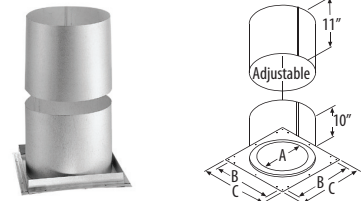

Attic Insulation Shield

Required for installations that pass through an attic to prevent insulation and debris from accumulating near the chimney.

SIZE	6"	List Price	7"	List Price	8"	List Price
A	8"		9"		10"	
B	14"		15"		16"	
STOCK #	6DT-IS	\$160.98	7DT-IS ❖	\$203.76	8DT-IS	\$215.68

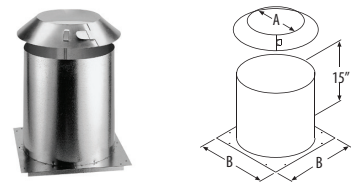

Chase Top Flashing

Encloses the top of the chase while providing a ventilation air passage from the chase.

SIZE	6"	List Price	7"	List Price	8"	List Price
A	11"		12"		13"	
B	19 3/4"		20 3/4"		21 3/4"	
STOCK #	6DT-CTF❖	\$106.27	7DT-CTF ❖	\$128.08	8DT-CTF ❖	\$114.07

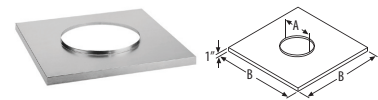

Adjustable Extended Roof Bracket

Use to support the chimney when it extends more than 5' above the roof.

SIZE	5"	List Price	6"	List Price
A	5" & 7"		6" & 8"	
STOCK #	5DT-XRS ❖	\$217.97	6DT-XRS ❖	\$217.97

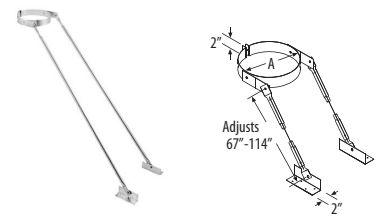

Locking Band

Use for extra security at pipe, elbow, and tee joints.

SIZE	6"	List Price	7"	List Price	8"	List Price
A	8"		9"		10"	
STOCK #	6DT-LB	\$20.30	7DT-LB ❖	\$21.87	8DT-LB	\$23.43



SOME BRANDS ARE ONLY AVAILABLE IN SELECTED AREAS, SEE MAP ON PAGE 4 OR CONTACT YOUR REGIONAL SALES MANAGER FOR MORE INFO.

Pricing, model numbers and availability are subject to change without notice. Call for most current information.

DSA Roof Flashings

Use w/ metal or tile roofs.

STOCK #	6"	List Price	8"	List Price
0/12 – 6/12	6DT-F6DSA	\$228.36	8DT-F6DSA ❖	\$279.67
7/12 – 12/12	6DT-F12DSA	\$364.37	8DT-F12DSA ❖	\$407.99

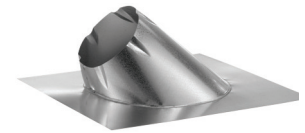
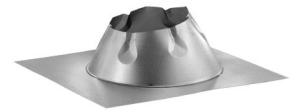

Roof Flashing

Use to weather-proof the penetration of chimney pipe through the roof. Storm collar required.

ADJUSTABLE SIZE		6"	List Price	7"	List Price	8"	List Price
0/12 – 6/12	A	8 1/2"		9 1/2"		10 1/2"	
	B	20"		21"		22"	
	C	27 3/16"		28 5/16"		29 1/2"	
	STOCK #	6DT-F6	\$164.08	7DT-F6 ❖	\$187.58	8DT-F6	\$204.72
7/12 – 12/12	A	8 1/2"		9 1/2"		10 1/2"	
	B	20"		21"		22"	
	C	30"		31 5/16"		33 1/4"	
	STOCK #	6DT-F12	\$212.58	7DT-F12 ❖	\$245.44	8DT-F12	\$265.74
FLAT ROOF		6"	List Price	7"	List Price	8"	List Price
	A	8 1/4"		9 1/4"		10 1/4"	
	B	20 11/16"		21 5/8"		21 5/8"	
	STOCK #	6DT-FF	\$220.41	7DT-FF ❖	\$254.78	8DT-FF ❖	\$267.29

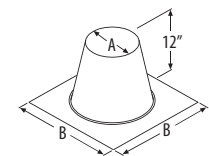
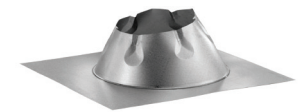
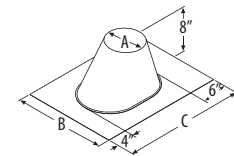

Venting Components – DuraTech

Storm Collar

Required w/ DuraTech flashing to create a weather-proof penetration through the roof deck.

SIZE	5" - 6"	List Price	7" - 8"	List Price
A	7" - 8"		9" - 10"	
B	12" - 14"		15" - 16"	
STOCK #	5DT-SC	\$29.66	7DT-SC	\$32.79

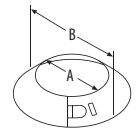

Chimney Cap

Required where pipe terminates above the roof line.

SIZE	6"	List Price	7"	List Price	8"	List Price
A	6"		7"		8"	
B	8"		9"		10"	
C	11"		15"		15"	
D	6 1/2"		6 1/2"		6 1/2"	
STOCK #	6DT-VC	\$179.75	7DT-VC ❖	\$245.44	8DT-VC	\$322.00

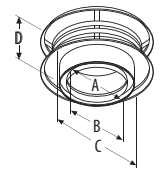

Spark Arrestor

Use on inside of cap.

SIZE	5" - 8"	List Price
STOCK #	5DT-SA	\$36.02

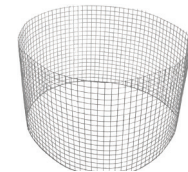

Firestop

SIZE	6"	List Price	8"	List Price
STOCK #	6DT-FS	\$110.85	8DT-FS	\$135.47

SOME BRANDS ARE ONLY AVAILABLE IN SELECTED AREAS, SEE MAP ON PAGE 4 OR CONTACT YOUR REGIONAL SALES MANAGER FOR MORE INFO.

Pricing, model numbers and availability are subject to change without notice. Call for most current information.